

**PARTS LIST**

Air deflector

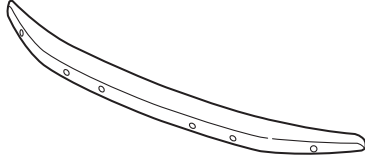

2 Inner brackets

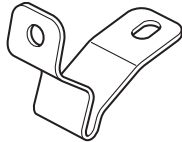

2 Middle brackets

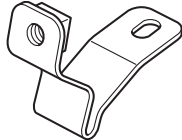

2 Outer brackets

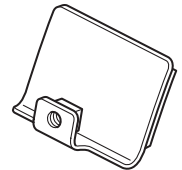

4 Plastic grommets



4 Screws, 10 x 24 mm



4 Screws, 6 x 10 mm



4 Protective tapes

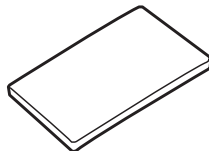

Alcohol pad

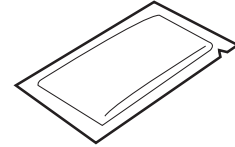

2 Clips



4 Collars



Template

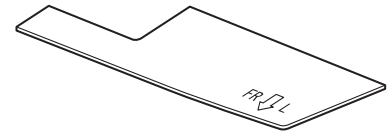

Warning label

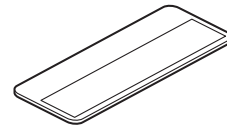
**TOOLS AND SUPPLIES REQUIRED**

Phillips screwdriver

Masking tape

Felt-tip pen

**INSTALLATION**

**Customer Information:** The information in this installation instruction is intended for use only by skilled technicians who have the proper tools, equipment, and training to correctly and safely add equipment to your vehicle. These procedures should not be attempted by "do-it-yourselfers."

**NOTE:**

- Be careful not to damage the body paint finish.
- This air deflector kit should be installed only if the ambient air temperature is above 15°C (60°F).
- To allow the adhesive to cure, do not wash the vehicle for 24 hours.

1. Open the hood. Under the rubber molding, locate the four square holes on the inside of the hood. Push one plastic grommet into each square hole.

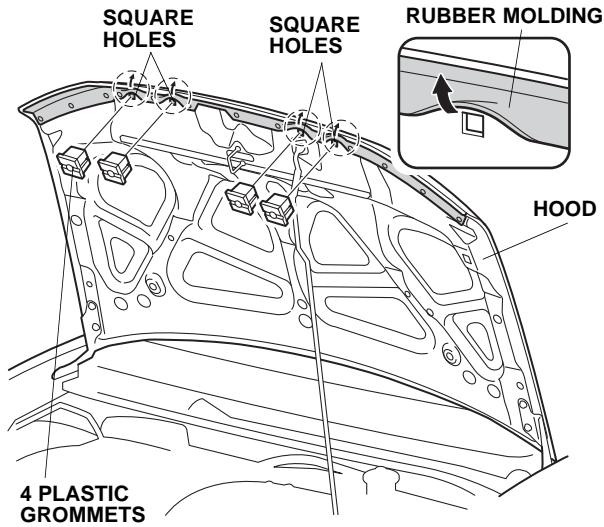

2. Using an alcohol pad, clean the hood where the protective tapes will attach. Allow the alcohol to dry.

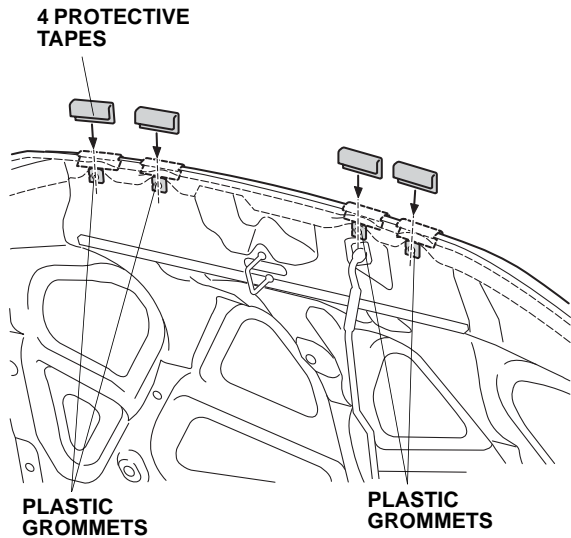

3. Attach a protective tape around the front lip of the hood at each grommet location.

4. Use four 10 x 24 mm screws to install two inner brackets and two middle brackets over the protective tapes of the hood. Do not tighten the screws yet. Push the brackets against the hood as you install them.

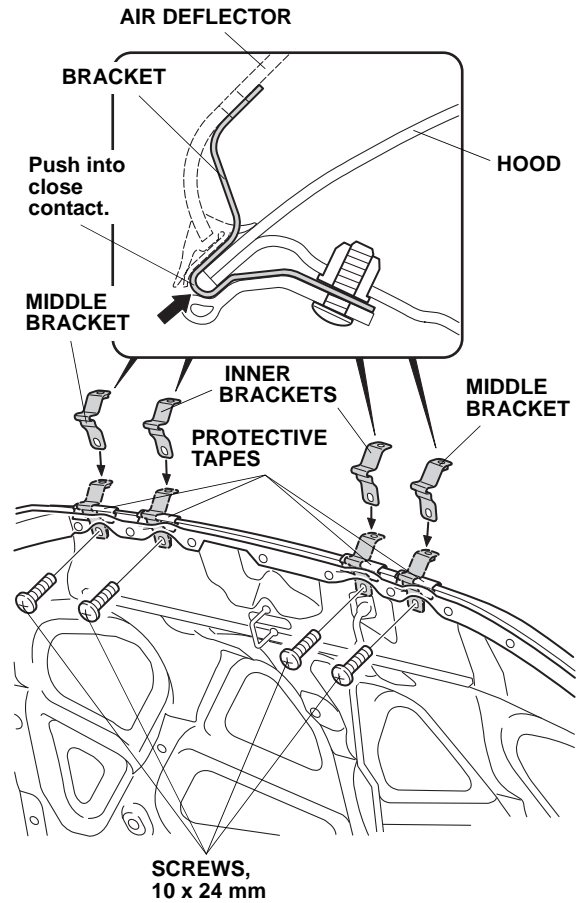

5. Close the hood. Position the template on the hood, and align its edges with the edges of the hood. Secure the template with masking tape as shown.

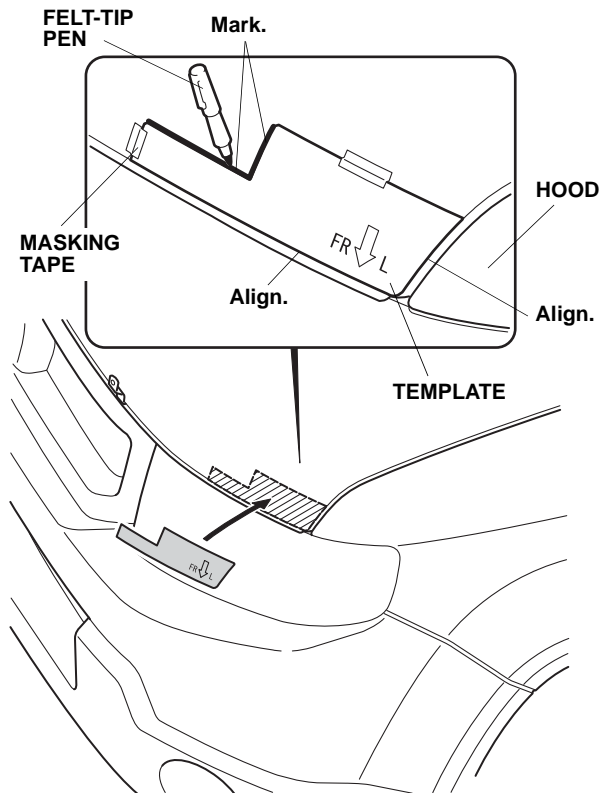

6. Using a felt-tip pen, mark the hood along the template as shown.
7. Remove the template.

8. Using an alcohol pad, clean the hood where the outer bracket will attach. Allow the alcohol to dry.

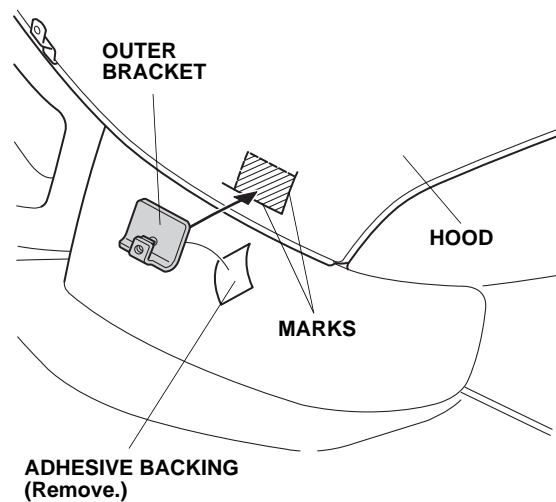

9. Remove the adhesive backing from the outer bracket, and attach it to the hood as shown.
10. Turn the template over and repeat steps 5 thru 9 to attach the outer bracket to the right side of the hood.

11. Position the air deflector on the hood, and align the holes in the air deflector with the holes in the six brackets.

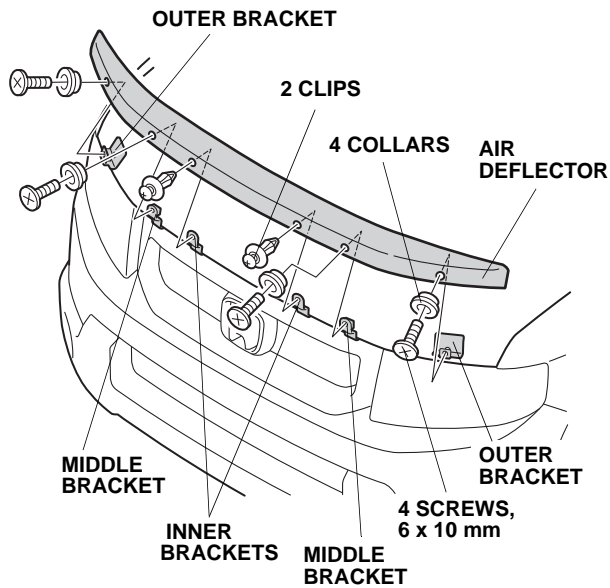

12. Install the four 6 x 10 mm screws and collars to the middle bracket and outer bracket holes. Install two clips to the inner bracket holes.
13. Open the hood, and tighten the four screws installed in step 4.
14. Apply the warning label under the hood in the location shown.

