



INSTALLATION INSTRUCTIONS

Accessory

ROOF RACK (LX)
P/N 08L02-S9V-102

Application

2005 PILOT

Publications No.

All 28071

Issue Date

SEP 2004

PARTS LIST

Right side rail

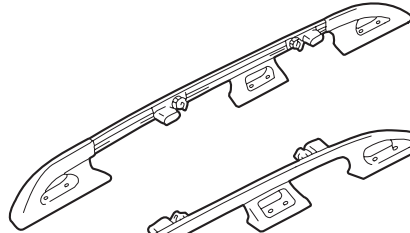

Left side rail

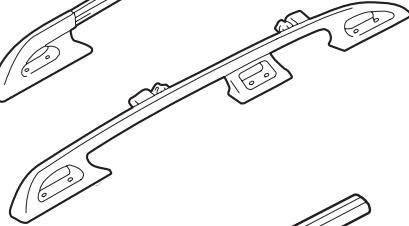

Front crossbar (long)



Rear crossbar (short)

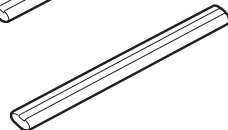

Adapter block, marked 1 (right front)

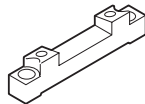

Adapter block, marked 2 (right center)

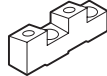

Adapter block, marked 3 (right rear)

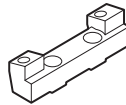

Adapter block, marked 4 (left front)

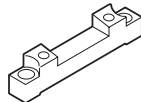

Adapter block, marked 5 (left center)

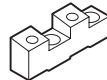

Adapter block, marked 6 (left rear)

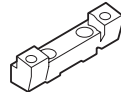

Support pad (left front)

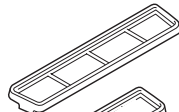

Support pad (left center)

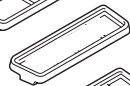

2 Support pads (left rear)

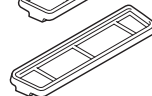

Support pad (right front)

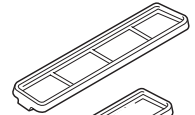

Support pad (right center)



Support pad (right rear)

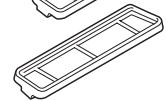

8 Torx self-tapping screws



4 Nylon washers



12 Torx nuts



12 Phillips screws (6 x 20 mm)



TOOLS AND SUPPLIES REQUIRED

#2 Phillips screwdriver

Flat-tip screwdriver

Torque wrench

Shop towel

T-25 Torx driver

Long-nose pliers

T-30 Torx driver

Hacksaw (32 tpi blade)

INSTALLATION

Customer Information: The information in this installation instruction is intended for use only by skilled technicians who have the proper tools, equipment, and training to correctly and safely add equipment to your vehicle. These procedures should not be attempted by "do-it-yourselfers."

NOTE:

- The weight of cargo must not exceed the maximum weight capacity: 100 lbs (45 kg).
- Be careful not to damage the roof and other finished surfaces of the body when installing the roof rack.
- Do not interchange the front and rear parts or the right and left parts.

Removing and Cutting the Roof Moldings

1. Place a shop towel under a flat-tip screwdriver, and pry up or the rear end of each roof molding.

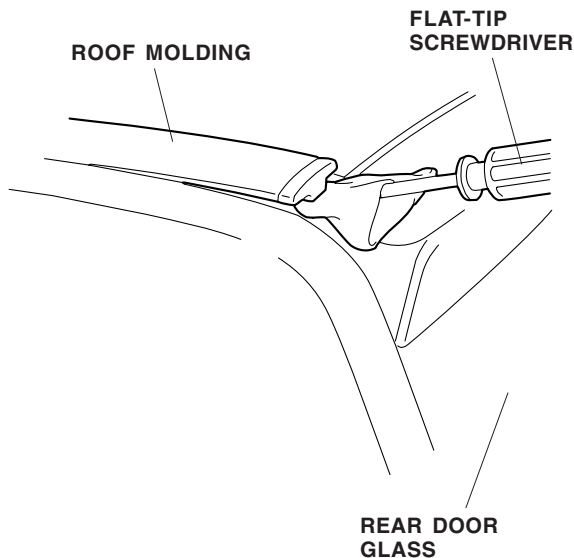

2. Remove the roof moldings by carefully pulling them upward.

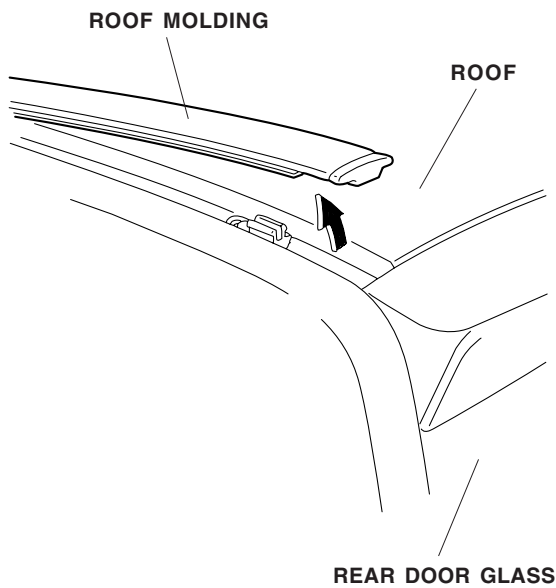

3. Using long-nose pliers, remove the eight retaining clips (four on each side) from the stud bolts. Discard four of the clips.

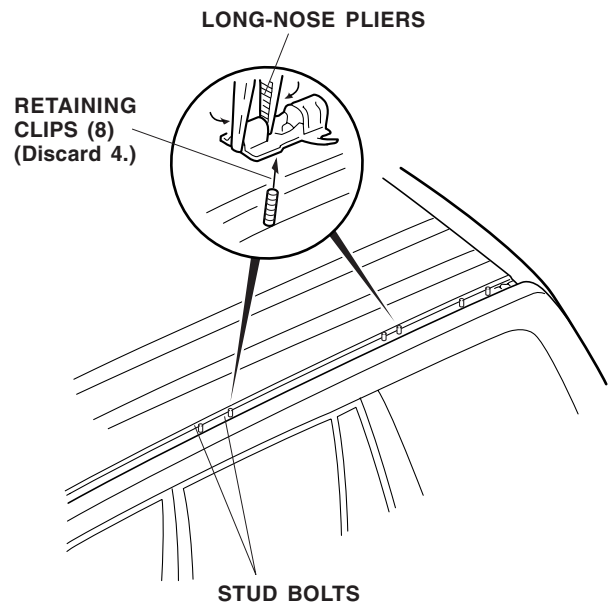

4. Position the adapters (as marked on each adapter) on the roof by aligning the nuts with the studs of the roof as shown. Install the Torx nuts on the studs, and torque them using a T-30 Torx driver to 7 to 10 N-m (5 to 8 lb-ft).

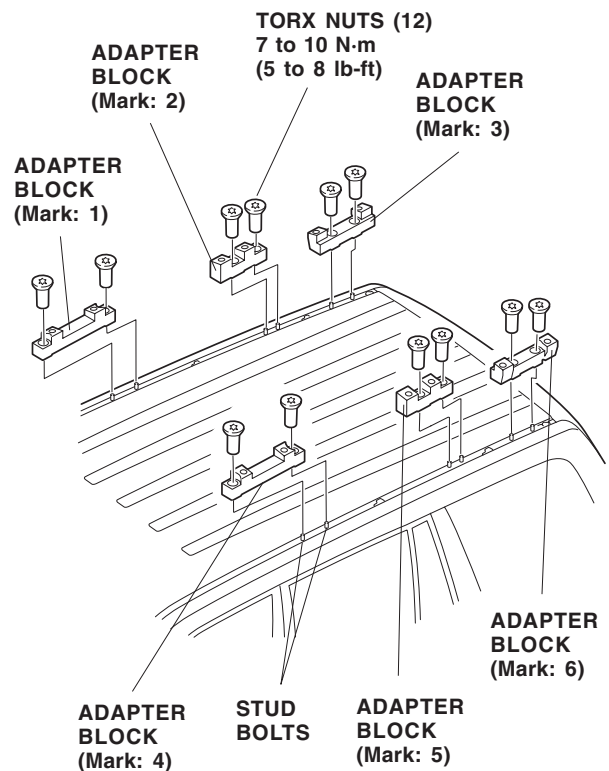

- Using a hacksaw, cut each roof molding according to the dimensions shown. Reinstall the moldings you just cut into the roof gutters.

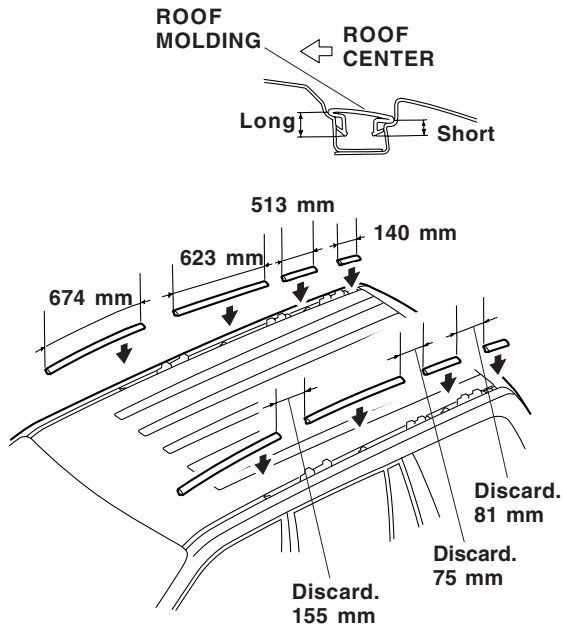

Installing the Roof Rack

- Align the left and right crossbar mounts with the arrow marks. The left side of the crossbar has elongated holes, and the right side has round holes. Also, check that all knobs are tightened securely.

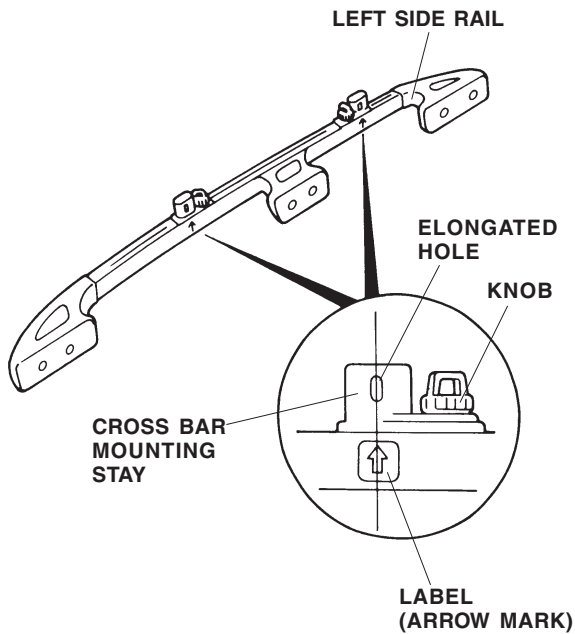

- If any holes are not aligned, loosen the knob and slide the mounting stay until the hole is aligned with the arrow mark. Retighten the knob securely.

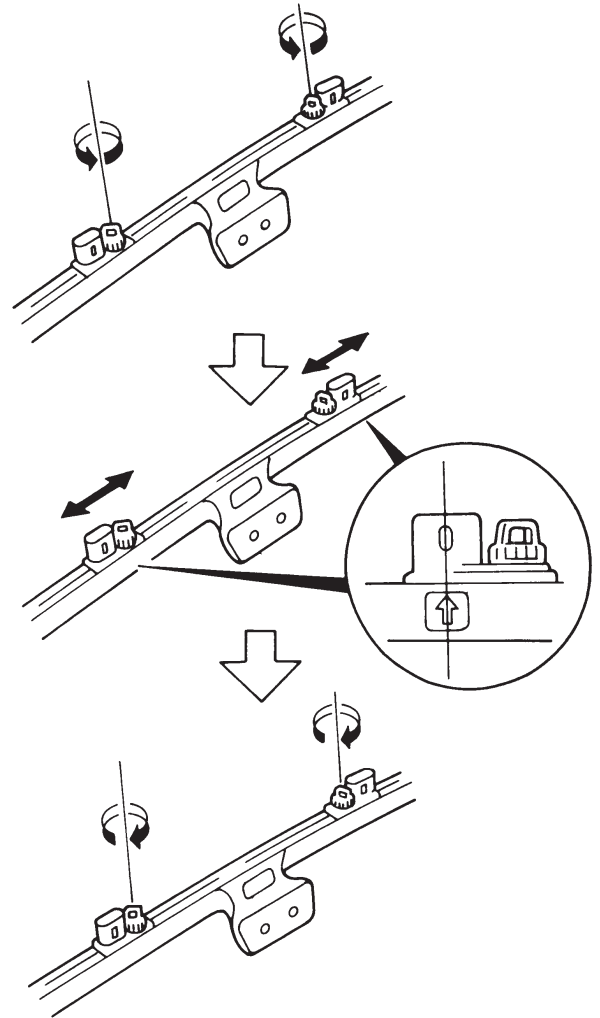

- Insert the crossbars into the right side rail in the direction shown; install the two Torx self-tapping screws into each side rail. Insert the crossbars into the left side rail, and install two Torx self-tapping screws and nylon washers into each elongated side rail. Tighten all Torx screws securely.

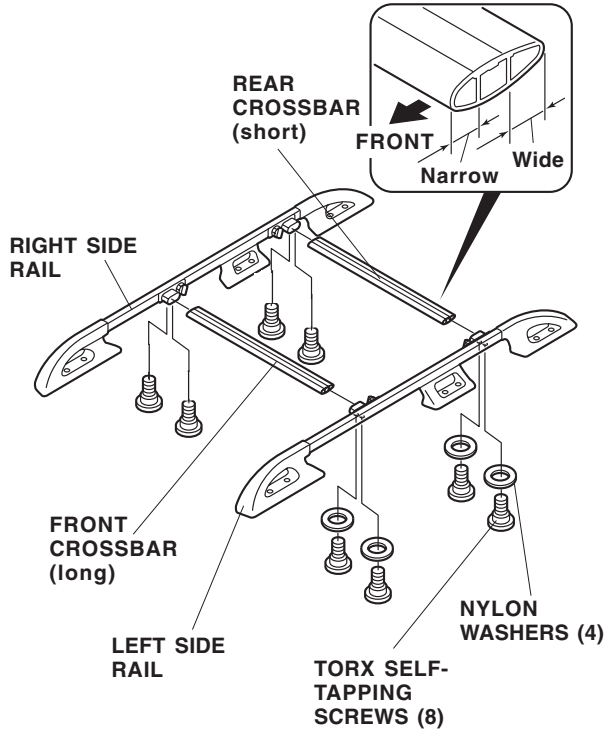

- Place the support pads (as marked on the pads) on the roof over the adapter blocks. Note the directional arrow on each pad.

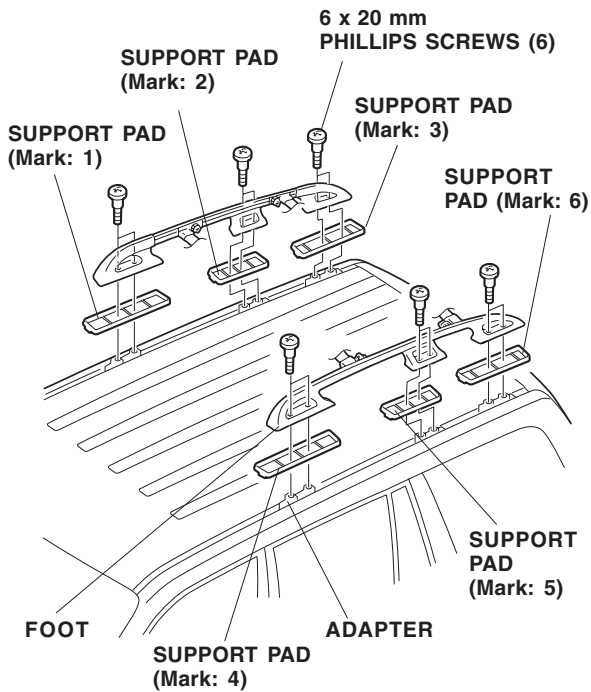

- Set the rack over the support pads and onto the adapter blocks (short crossbar to the rear), and adjust the left side rail in-or-out until you can install the 12 Phillips screws into each adapter block. Torque the Phillips screws to 7 to 10 N·m (5 to 8 lb-ft).

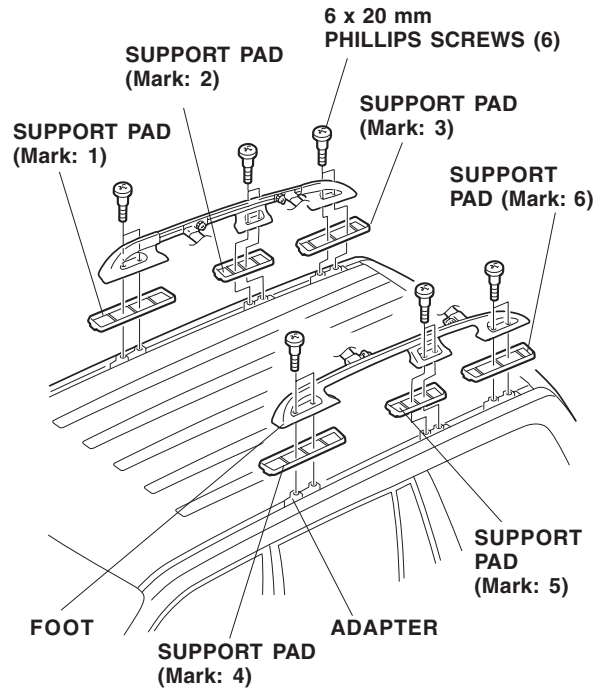

- Rock the roof rack in all directions to check that it is mounted securely without play or rattle.

