

**PARTS LIST**

Right front door edge guard

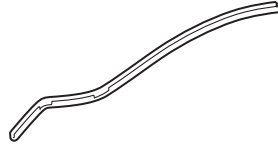

Left front door edge guard

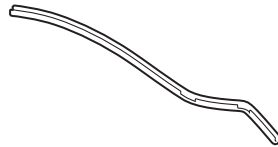

Right rear door edge guard



Left rear door edge guard

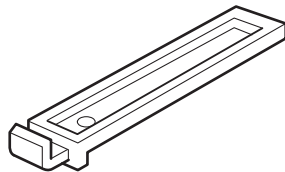

Seam sealant cutting tool

**TOOLS AND SUPPLIES REQUIRED**

Rubber mallet

Felt-tip pen

Touch-up paint

High quality paste wax

**INSTALLATION**

**Customer Information:** The information in this installation instruction is intended for use only by skilled technicians who have the proper tools, equipment, and training to correctly and safely add equipment to your vehicle. These procedures should not be attempted by “do-it-yourselfers.”

**NOTE:**

- Door edge guards cannot be installed if the vehicle already has body side moldings installed.
  - If you are also installing body side moldings (sold separately), install them after you install the door edge guards.
  - These instructions show the left door edge guards being installed. The same procedure applies to installing the right door edge guards.
  - Be careful not to damage the body paint finish.
1. Clean and wax the areas to be covered with a high quality paste wax.
  2. Identify each door edge guard by holding it up to the door and matching its contour with the door edge.

3. Gently place the left front door edge guard on the left front door. Align the left front door edge guard with the contour of the door. Mark the sealant at the top and bottom edges of the left front door edge guard.

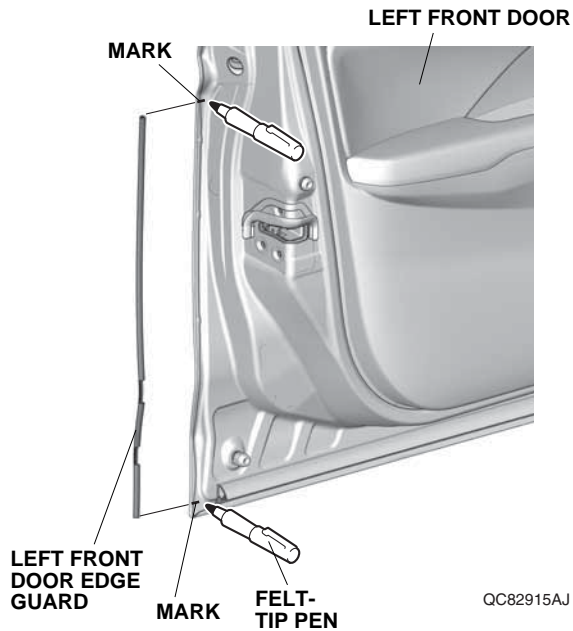

4. Remove the left front door edge guard.
5. Position the cutting edge of the seam sealant cutting tool against the door edge and trim the seam sealant from mark to mark. The cutting tool cuts in only one direction.

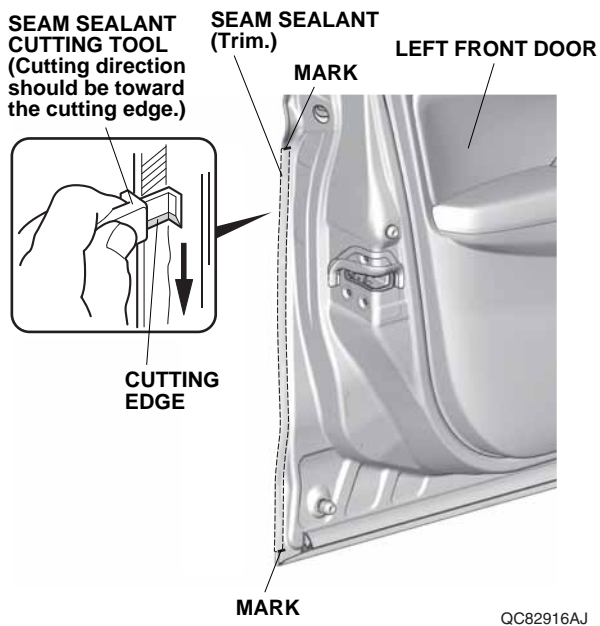

6. Apply touch-up paint to the cut seam sealant area, and let it dry thoroughly.

7. Position the left front door edge guard on the left front door edge and align it with the marks made in step 3.

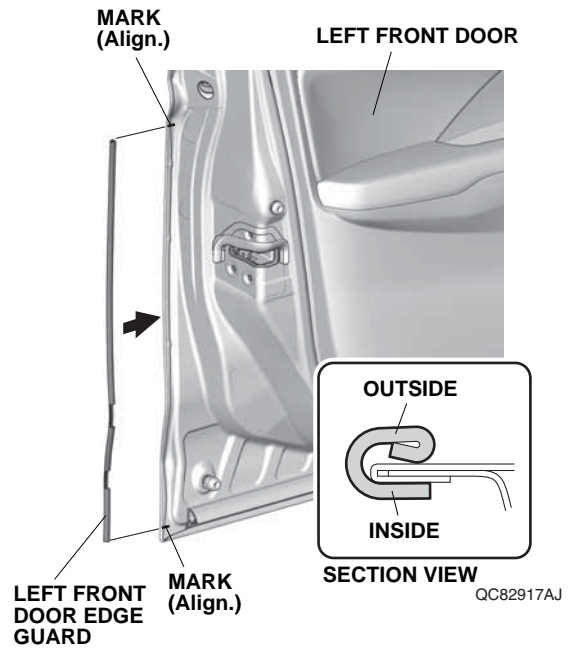

8. Starting at the feature line, use a rubber mallet to tap the left front door edge guard into position with a series of light taps, then work up and down. Once in place, do not attempt to remove, reposition, or reinstall the left front door edge guard.

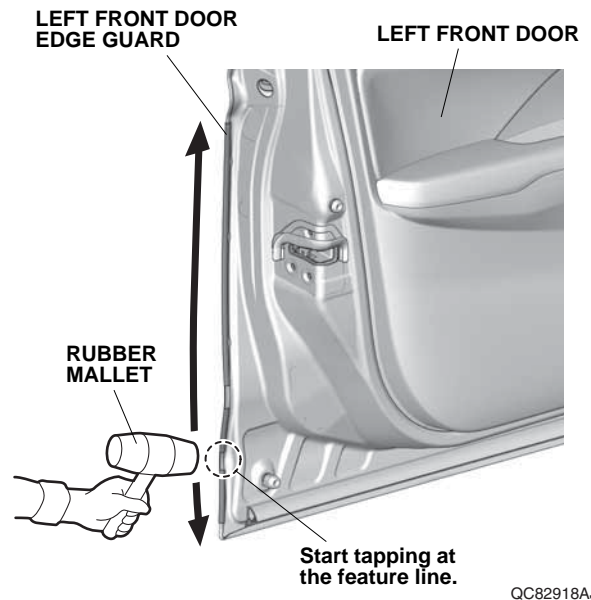

- Gently place the left rear door edge guard on the left rear door. Align the left rear door edge guard with the contour of the door. Mark the sealant at the top and bottom edges of the left rear door edge guard.

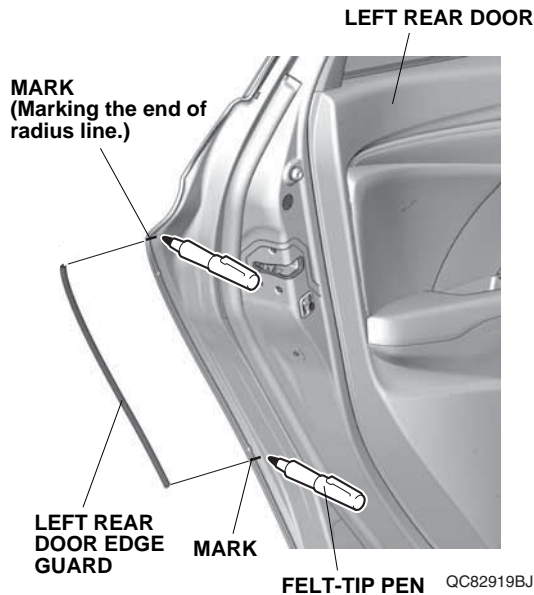

- Remove the left rear door edge guard.
- Position the cutting edge of the seam sealant cutting tool against the door edge and trim the seam sealant from mark to mark. The cutting tool cuts in only one direction.

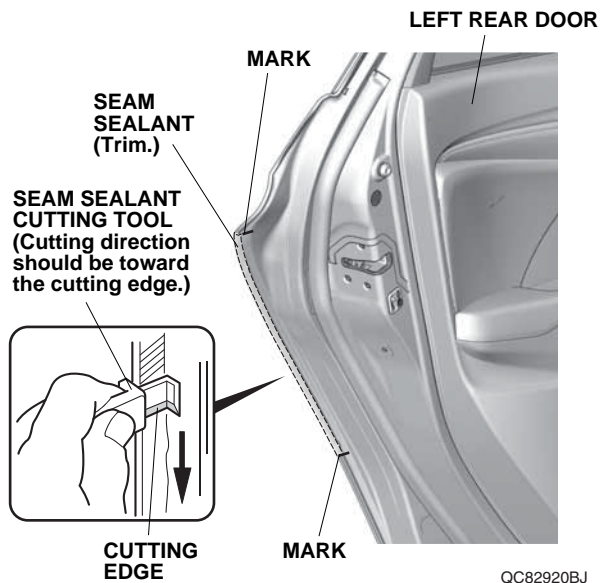

- Apply touch-up paint to the cut seam sealant area, and let it dry thoroughly.
- Position the left rear door edge guard on the left rear door edge and align it with the marks made in step 9.

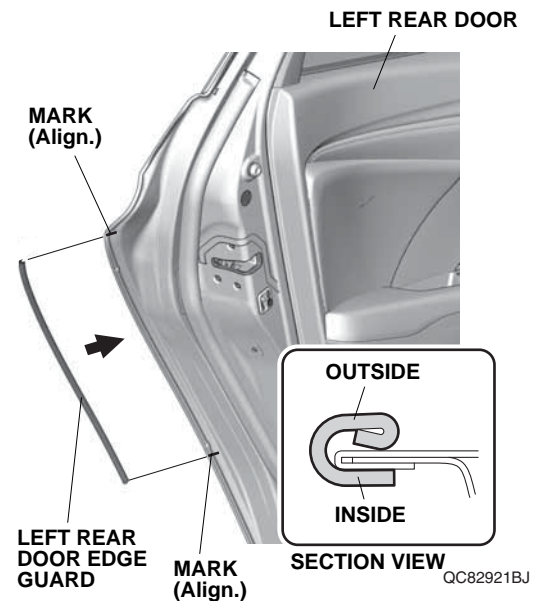

- Starting at the upper side, use a rubber mallet to tap the left rear door edge guard into position with a series of light taps, then work down. Once in place, do not attempt to remove, reposition, or reinstall the left rear door edge guard.

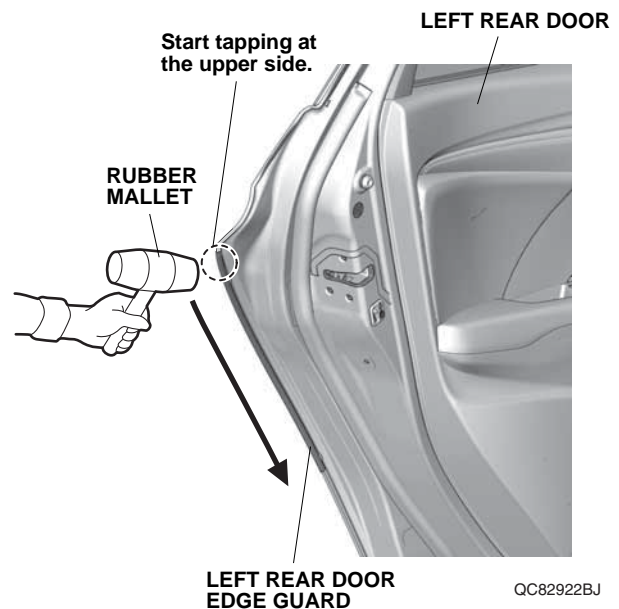

- Repeat steps 3 through 14 to install the right door edge guards.