



INSTALLATION INSTRUCTIONS

Accessory
ALL-SEASON FLOOR MATS
(High Wall)
P/N 08P17-TBA-300

Application
2017 CIVIC
4- AND 5-DOOR

Publications No.
VERSION 1
Issue Date
SEP 2016

PARTS LIST

Driver's all-season floor mat



Passenger's all-season floor mat



Left rear all-season floor mat



Right rear all-season floor mat



Illustration of the All-Season Floor Mats in the Vehicle

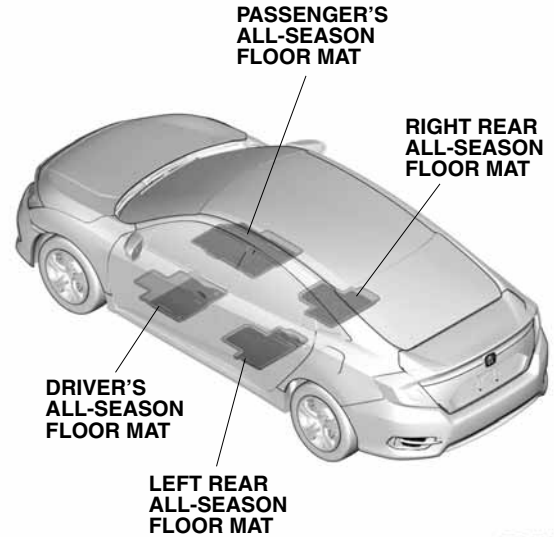

QE30601AU

INSTALLATION

NOTE:

- Before installing the mats, identify their installation positions.
- Connect the driver's side floor mat to the anchors to prevent the mat from sliding forward and possibly interfering with the pedals.
- If you remove a mat, make sure you anchor it when you put it back in your vehicle.
- If you replace a mat, use a factory mat designed to be used with the anchors.
- If you use a non-factory mat in the driver's footwell, make sure it fits properly and that it can be used with the anchors.
- Do not put an additional mat on top of the anchored mat. An additional mat may slide forward and possibly interfere with the pedals.

Installing the All-Season Floor Mats

1. Remove the floor mats as described in the vehicle owner's manual.

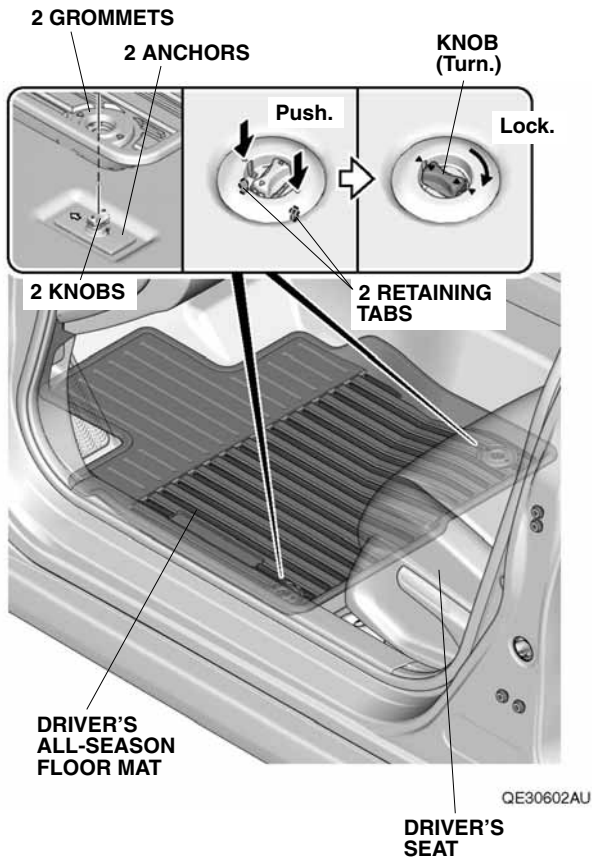

2. Place the grommets in the driver's all-season floor mat over the anchors. Push the grommets into the anchors to secure the retaining tabs, then turn the knobs 90° to secure the all-season floor mat.

3. Place the passenger's all-season floor mat as shown.

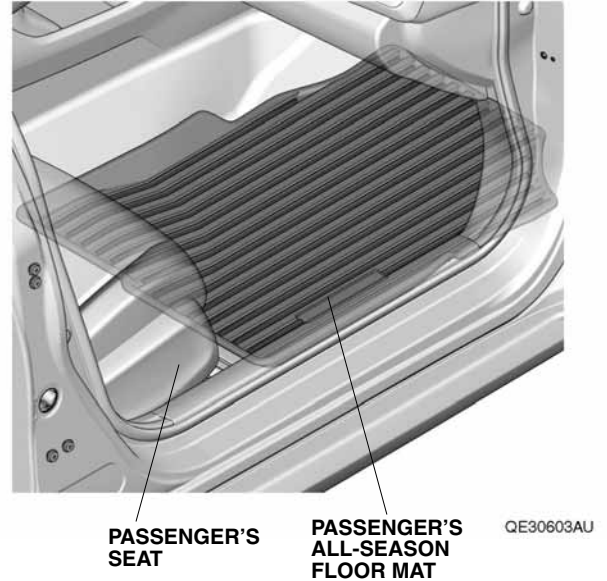

4. Place the left rear all-season floor mat as shown.

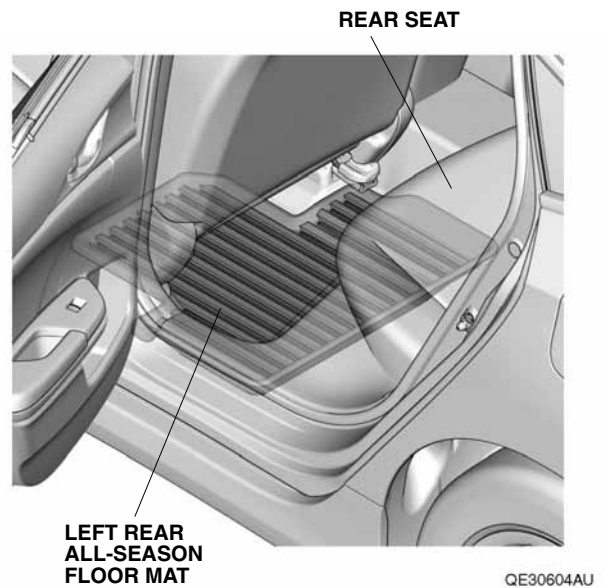

5. Repeat step 4 to install the right rear all-season floor mat on the right side of the vehicle.